

ELEGANCE

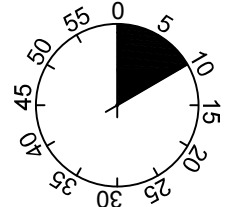

1

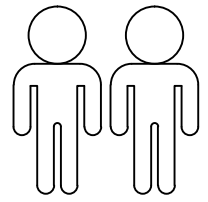
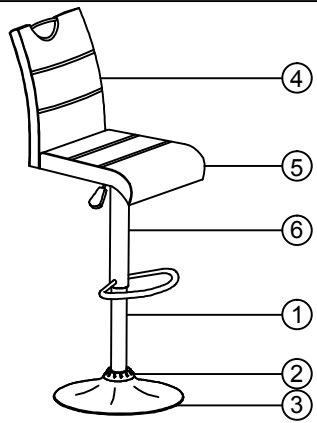

2



3



4

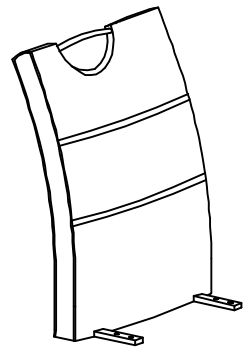

5

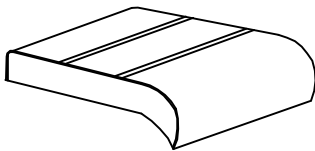

6

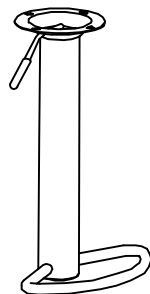

| | |
|---|----|
| 1 | 1X |
| 2 | 1X |
| 3 | 1X |
| 4 | 1X |
| 5 | 1X |
| 6 | 1X |

A

M6X18

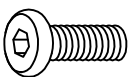

4x

B

M6x12

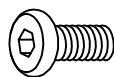

4x

C

Ø13xØ6x1.2

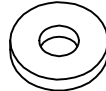

4x

D

4MM

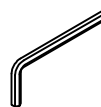

1x

E

5MM

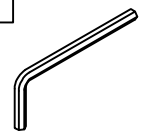

1x

I.



1

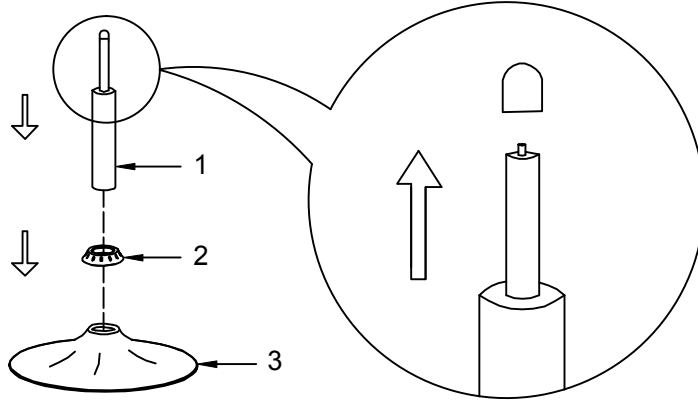

2

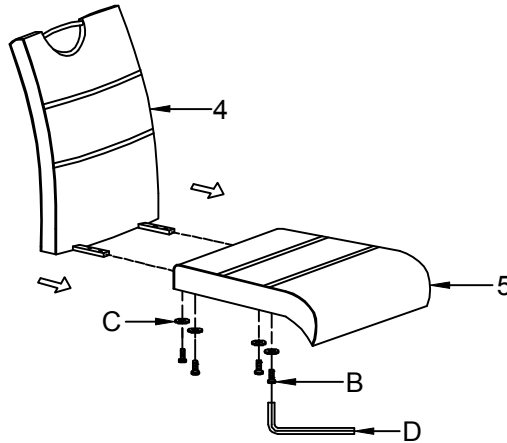

| | |
|----------|------------|
| B | M6x12 |
| | 4x |
| C | Ø13xØ6x1.2 |
| | 4x |
| D | 4MM |
| | 1x |
| | |

3

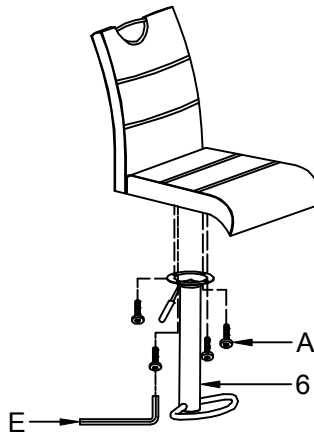

| | |
|----------|-------|
| A | M6X18 |
| | 4x |
| E | 5MM |
| | 1x |
| | |

4

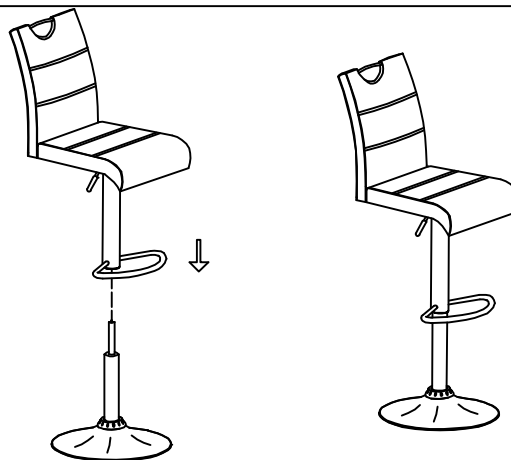

| | |
|----------|-----|
| D | 4MM |
| | 1x |
| | |

